



GLOBAL JOURNAL OF SCIENCE FRONTIER RESEARCH: A
PHYSICS AND SPACE SCIENCE

Volume 18 Issue 11 Version 1.0 Year 2018

Type : Double Blind Peer Reviewed International Research Journal

Publisher: Global Journals

Online ISSN: 2249-4626 & Print ISSN: 0975-5896

Macroscopic Crystallization of Magnetic Moments in the Ferrite Rings

By F. F. Mende

Abstract- Ferrite is soft-iron material and therefore it cannot be magnetized. However, the rings, made from ferrite, can be magnetized in the assigned direction. This special feature of the magnetization of such rings did not have, until now, of physical substantiation. In the article are examined the processes of the magnetization of the models of different configuration, including annular. It is shown that the magnetization of ferrite rings can be considered as the forced crystallization of magnetic moments.

Keywords: magnetic field, magnetic moment, ferromagnetic material, ferrite, magnetic bubble.

GJSFR-A Classification: FOR Code: 020404



MACROSCOPICCRYSTALLIZATIONOFMAGNETICMOMENTSINTHEFERRITERINGS

Strictly as per the compliance and regulations of:



RESEARCH | DIVERSITY | ETHICS

Macroscopic Crystallization of Magnetic Moments in the Ferrite Rings

F. F. Mende

Abstract- Ferrite is soft-iron material and therefore it cannot be magnetized. However, the rings, made from ferrite, can be magnetized in the assigned direction. This special feature of the magnetization of such rings did not have, until now, of physical substantiation. In the article are examined the processes of the magnetization of the models of different configuration, including annular. It is shown that the magnetization of ferrite rings can be considered as the forced crystallization of magnetic moments.

Keywords: magnetic field, magnetic moment, ferromagnetic material, ferrite, magnetic bubble.

I. INTRODUCTION

Soft-iron materials these are the materials, which possess the properties the ferromagnetic material or the ferrimagnet, moreover of them the coercive force by the induction comprises not more than 4 kA/m. Such materials also possess the high by magnetic permeability and by low losses on hysteresis. In connection with the smallness of coercive force such materials cannot be magnetized and lose magnetization after the removal from them of magnetic field.

Soft-iron materials are used as the cores the transformers, electromagnets, in the meters and in other cases, where it is necessary with the smallest expenditure of energy to reach the greatest the induction. For decreasing the losses on the eddy currents in the transformers soft-iron materials with that increased are used they are commonly used, by resistivity in the form magnetic circuits, the assembled from separate isolated from each other thin sheets. Sheets are insulated by varnish from each other. This performance of core is called charged.

The soft-iron materials include ferrites, which possess high specific resistance, and they can work at the high frequencies.

However, from the above-indicated rule there are exception. It occurs that the rings, made from soft-iron materials, they can be magnetized, preserving in itself the magnetic induction, with which magnetic lines of force compose the annular circles, inserted in the material of ring. In this case depending on the prehistory of magnetization the direction of magnetic lines of force can be directed both to one and to other side.

The idea of the memory unit in the form of ferrite core matrix for the first time arose in 1945 to the year u John Prespera Ekerta, its report widely circulated

among the American computer specialists. In 1949 to the year Van An and In Vo Vaydun - the young colleagues Harvard University Chinese origin- they invented the shift register on the magnetic cores (Van named it pulse transfer controlling device) and the principle "record - readout- restoration", which made it possible to use cores, whose process of readout destroys information. In October 1949 the year of Vans it gave patent application, and was obtained it in 1955 the year [1]. To the middle of the 1950 of past century the magnetic-core storage already received wide acceptance. Van gave to the law court to IBM, and IBM it was necessary to redeem patent in Van after \$500 000.

Meanwhile, Jay Forrester in Massachusetts Institute of Technology it worked at the computer system Whirlwind ("Vortex"). In 1949 the year, just as in Van, in Forrester arose the idea about the magnetic-core storage. According to the assertions of Forrester himself, it arrived at this solution independent of Van. In March 1950 the year Forrester with his command developed the ferrite memory, which works according to the principle of the agreement of currents; the proposed by them diagram with four sensing wires - X, Y, prohibition - became conventional. In May 1951 the year Forrester gave patent application, and was obtained it in 1956 the year [2].

II. PROPERTIES OF FERRITE CORES AND THEIR USE AS THE MEMORY ELEMENTS

The physical properties of ferrite cores are critically important for the functioning of memory; therefore it is very important to understand them. The diagram of the functioning of memory element on the ferrite core is depicted in Fig. 1.



Fig. 1: Diagram of the functioning of memory element on the ferrite core

Author: e-mail: fedormende@gmail.com

The conductors, passing through the core, have the following designation: X, Y, - the wire of excitation, S - readout, Z - prohibition.

If heavy current is passed along the wire through the core, then core will be magnetized in accordance with the direction of flow (on to the right-hand rule). Current in one direction will write down into the core "unit", current will in the opposite direction cause opposite magnetization and will write down into the core "zero".

The very important parameter of core is its giserezis: current must exceed the specific threshold in order to influence the magnetization of core. Low current will show no effect, but the current of higher than the specific threshold will lead to the passage into the magnetized state in accordance with the direction of flow.

The property of hysteresis makes the selection of concrete core in the memory system possible. "Half" current is sent along the appropriate wire of excitation X, and "Half" current - on the appropriate wire of the excitation Y. Thus, only this only core among thousands of rest will obtain the current, sufficient for changing its state.

Last important property consists in the fact that when the core changes the direction of magnetization, it induces current in the sensing wire, passing through this

core. If the direction of magnetization does not change, then there is no current there. This induced current is used for the readout of the state of the bit of memory. As consequence, with the readout of information from the core information is erased and must be rewritten. In Fig. 2 is depicted memory matrix on the magnetic cores.

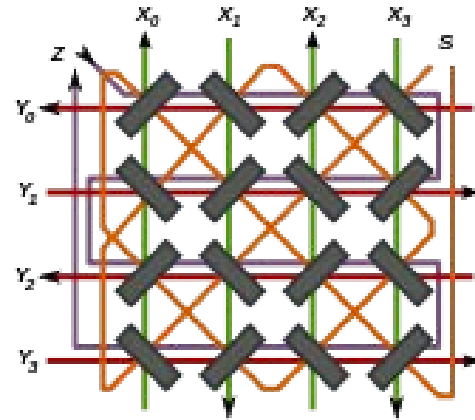

Fig. 2: Memory matrix on the magnetic cores

Memory elements on the magnetic cores received wide acceptance in the 60- tenth years of past century. The matrices of ferrite memory and their use in the composition of computers are depicted in Fig. (3-5).

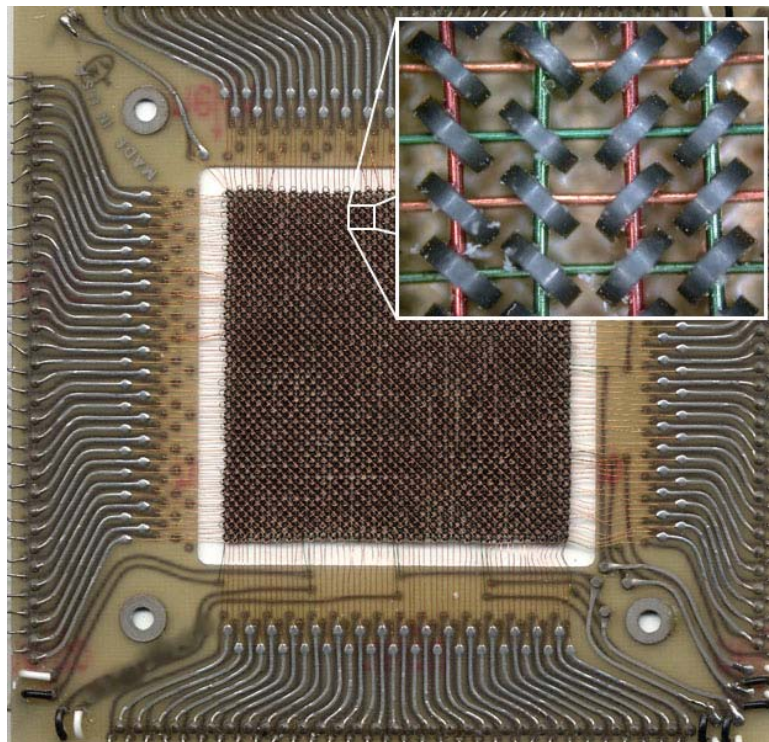

Fig. 3: Matrix of the ferrite memory of the super-computer CDC 6600 (1964). Size 10,8×10,8cm, the capacity 4096 the bit

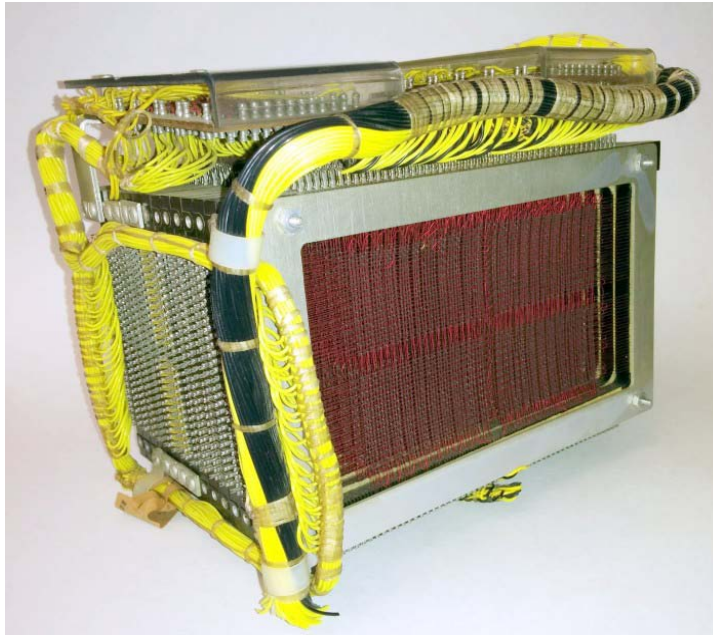

Fig. 4: Module of ferrite memory on 4000 symbols in meynfreyme IBM 1401

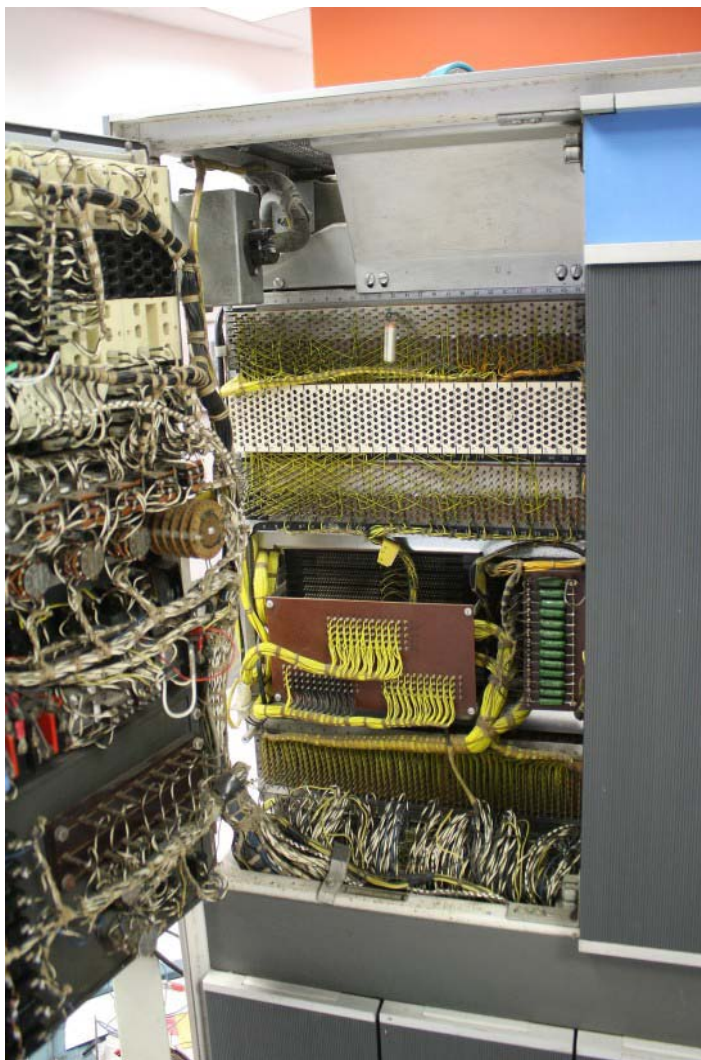

Fig. 5: Module of magnetic-core storage (in the center) on meynfreyme 1401

Meynfrey IBM 1401 was developed in 1959 the year, and it became to the middle of the 60th by the most popular computer in the world, considerably anticipating competitors. Special demand it enjoyed in the average and large business, in view of its cheapness. The key factor of success 1401 was its magnetic-core storage (ferrite memory) on 4000 the symbols, where the data were stored on the tiny ferrite rings.

It should be noted that, until now, it is not clear in conclusion, why the ferrite cores, made from soft-iron material, can be magnetized in the determinate direction and the physical mechanism of this process, until now, is not opened.

III. SELF-INDUCTION AND ENERGY OF THE MAGNETIC FIELD

Self-induction it is an important special case of the electromagnetic induction, when the changing magnetic flux, which causes the electromotive force (EMF) of induction, is created by current in the outline itself. If current in the outline for some reasons in question changes, then changes the magnetic field of this current, and, therefore, also its own magnetic flux, which penetrates outline. In the outline appears emf of self-induction, which accordingly to Lenz's rule it prevents a change of the current in the outline.

Its own the magnetic flux Φ , the penetrating outline or coil with the current, is proportional to current strength I :

$$\Phi = LI.$$

Constant of proportionality L in this formula it is called by the coefficient of the self-induction or by the inductance coil. As an example let us calculate the inductance of the long solenoid, which has, N turns, sectional area S and the length l . The magnetic field of solenoid is determined by the formula

$$B = \mu_0 nI,$$

where I – current in the solenoid, $n = N/l$ – the number of turns per unit of the length of solenoid.

Magnetic flux, which penetrates everything N the turns of solenoid, it is equal

$$\Phi = BSN = \mu_0 n^2 SI l.$$

Consequently, the inductance of solenoid is equal

$$L = \mu_0 n^2 SI l = \mu_0 n^2 V,$$

where $V = Sl$ – the volume of the solenoid, in which is concentrated the magnetic field. The obtained result does not consider edge effects; therefore it is approximately valid only for the sufficiently long solenoids. If solenoid is filled with substance s by magnetic permeability μ , that with the assigned current I the induction of magnetic field grows on the module μ ; therefore the inductance of coil with the core also increases μ :

$$L_\mu = \mu L = \mu_0 \mu n^2 V.$$

EMF of self-induction, appearing in the coil with the constant value of inductance, accordingly Faraday law it is equal

$$EMF_{ind} = EMF_L = -\frac{\Delta\Phi}{\Delta t} = -L \frac{\Delta I}{\Delta t}.$$

Magnetic field possesses energy. Similarly, as in the charged capacitor there is it stored up electrical energy, in the coil, over turns of which the current flows, there is it stored up magnetic energy. If we switch on electric lamp in parallel to coil with the large inductance in the electrical direct-current circuit, then with breaking of key is observed short-term flash lamp (Fig. 6). Current in circuit appears under the action emf of self-induction. The source of the energy, which separates in this case in the electrical chain, the magnetic field of coil is.

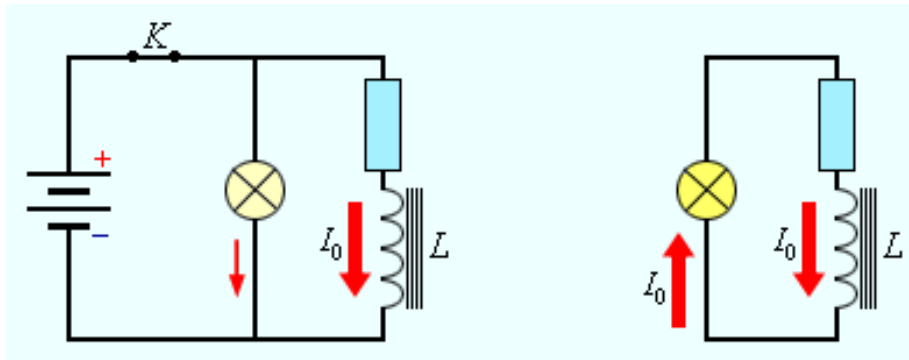

Fig. 6: With closing of key k the lamp vividly flares up

It follows from the law of conservation of energy that entire energy, stored up in the coil, will be isolated in the form Joule heat. If we designate through R the

impedance of chain, then in the time Δt a quantity of the heat will be isolated $\Delta Q = I^2 R \Delta t$.

Current in circuit is equal

$$I = \frac{EMF_L}{R} = -\frac{L \Delta I}{R \Delta t}$$

Expression for ΔQ it is possible to write down in the form

$$\Delta Q = -LI\Delta I = -\Phi(I)\Delta I$$

In this expression $\Delta I < 0$, and current in circuit gradually diminishes from the initial value I_0 to zero. A total quantity of heat, which was isolated in the chain, can be obtained, after performing the operation of integration in the limits from I_0 to zero. This it gives

$$Q = \frac{LI_0^2}{2}$$

Thus, the energy W_M the magnetic field of coil with the inductance L , created by the current I , it is equal

$$W_M = \frac{\Phi I}{2} = \frac{LI^2}{2} = \frac{\Phi^2}{2L}$$

Let us apply the obtained expression for the energy of coil to the long solenoid with the magnetic core. Using the formulas for the coefficient of the self-induction given above

L_μ solenoid and for the magnetic field B , created by the current I , it is possible to obtain:

$$W_M = \frac{\mu_0 \mu n^2 I^2}{2} V = \frac{B^2}{2\mu_0 \mu} V,$$

where V – the volume of solenoid. This expression shows that magnetic energy is localized not in the turns of the coil, over which the current flows, but it is distributed throughout entire volume, in which is created the magnetic field. Physical quantity

$$W_0 = \frac{B^2}{2\mu_0 \mu}$$

equal to energy of magnetic field per unit of volume, is called with the bulk density of the magnetic energy.

IV. THE MECHANICAL ANALOG OF THE SELF-INDUCTION

In the previous division it was shown that the presence of ferromagnetic core in the coil essentially increases its inductance. But physics of this process is nowhere described.

It was considered Until now that energy is determined by those magnetic fields, which are connected with the inductance. Let us describe the mechanism, which explains this phenomenon (Fig. 7).

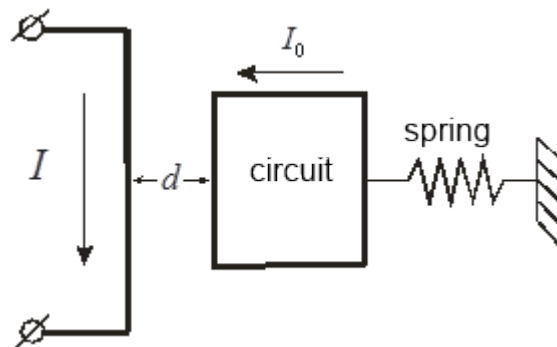

Fig. 7: Outline with the frozen current near the conductor, along which flows the current

Let us assume that we have the superconductive outline, in which is frozen the current I_0 (which is equivalent to the magnetic moment of atom in the ferromagnetic material), located at a distance d from the conductor, along which flows the current I . Outline with the frozen current is fixed with the aid of the spring to the rigid base. If we carry the current through conductor, then outline with the frozen current will begin to it to be attracted, extending spring and thus, stocking in the spring energy. Moreover, the greater the current in the outline will be, the stronger it will be attracted to the wire, and the greater the energy will be accumulated in the spring. Therefore with one and the same values of current in the conductor, the energy, spent for the tension of spring, will be different and there will be it to zavissetakzhe, also, from the current in the short-circuited outline. The system examined is equivalent to inductance with the only difference that energy in this inductance will be equivalent accumulated not in the magnetic field, but in the spring. Moreover inductance in this case will depend also on the distance between the outline and the conductor, and from the current, which flows along the conductor also of the current, frozen in the outline. The characteristic property of the system examined is the fact that the approximation of outline with the frozen current to the wire, along which flows the current, will lead to the excitation it the currents, opposite to initial current. Thus, the resulting current will prove to be less than that current, which would take place in the absence of outline with the frozen current. This behavior of summed current testifies about loading of wire, along which flows the current. If we rapidly turn off current in the outline, then outline with the frozen flow, returning to the previous state, will direct in the conductor emf. This process is equivalent to self-induction.

It is possible to present another form of such an interaction (Fig. 8). For this it is necessary outline with the frozen current to place on the axis, which passes, through its center, and to the axis to fasten the helical spring, which ensures the steady state of outline in the

situation, when its conductors are exist equidistantly from the conductors of outer ducts. Then with the flow of the current through conductor outline with the frozen current will be turned in that or other side, turning helical spring. In this case in the spring the energy will be accumulated, and the direction of the twisting of spring will depend on direction of flow in the conductor.

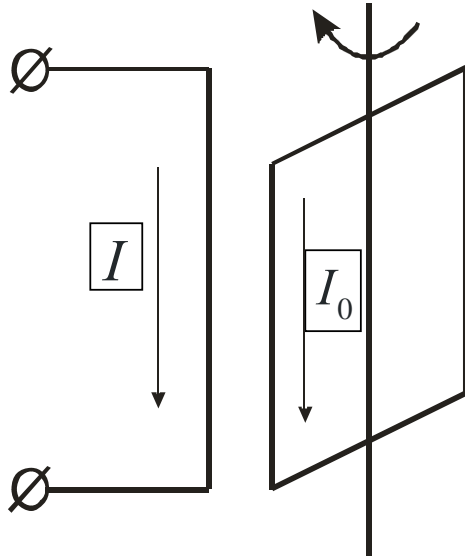

Fig. 8: Outline with the frozen current near the conductor, along which flows the current

Until to the ferromagnetic material is superimposed strange external magnetic field, its atoms or the molecules, which represent the microscopic of outline by the szamorzhennym current, they be in the disordered state. This state appears for them it is equilibrium.

Let us take ferrite and will wind winding around it. If we into the winding introduce current, then rod will begin to be magnetized. But external magnetic field as soon as is superimposed on the ferromagnetic material, in it the orientation of magnetic moments along the field begins to occur, on what the energy is expended, since the magnetic moments, located in parallel, are repulsed. But if current in the winding rapidly was turned off, magnetic moments will begin to pass into the initial disordered state and in the winding it will be induced by EMF.

V. FORCED MACROSCOPIC CRYSTALLIZATION OF MAGNETIC MOMENTS IN THE FERRITE RINGS

As was noted in the division 4, the carried out examination of the processes of self-induction it is approximate, since with this examination were not taken into account the magnetic fields of the scatterings, which be present around the magnetized model (Fig. 9). These fields also possess additional energy and makes

a contribution to the general energy of the magnetic field of the magnetized model. Any system is approached the minimization of its free energy and if we roll up the magnetized model into the ring and to magnetize it, then stray fields will be absent. In this case this configuration will correspond to the minimum of free energy. But if we in the magnetized annular model make the clearance, located across the ring, then stray fields there are formed. But since in this case at the opposite ends they are formed the pole of different signs, such of pole will be attracted, attempting to make free energy of the split ring of minimum, attempting to roll up it into the ring.

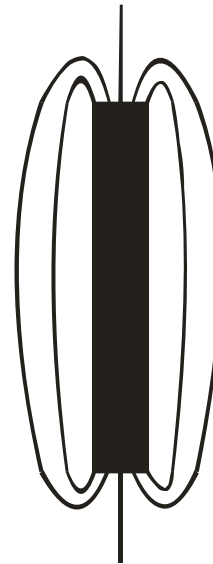

Fig. 9: Stray fields of the magnetized model

With this process in the magnetized ferrite ring the magnetic moments will be located in the strictly defined order, and their vector will be directed to one side, as shown in Fig. 10.

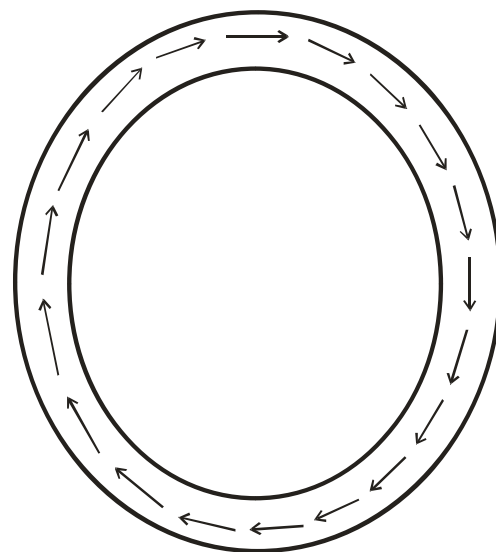

Fig. 10: Structure of magnetic moments in the magnetized ferrite ring

In this structure will be absent the stray fields, and structure itself will be steady, since the origin of the previous vector of magnetic moment is attracted the toward the end following vector. This case is very similar to the linear crystallization of atoms in the rod, bent into the ring, with the only difference that atom sites occupy magnetic moments.

If ring was reversed magnetism, then the vector of magnetic moments they change their direction, but their structure will as before remain stable after the removal of magnetizing field.

It is known that in the magnetic crystals also there are microscopic domains, in which the magnetic moments are spontaneously oriented to one side. Domains of exist in ferromagnetic, antiferromagnetic, ferroelectric the crystals and other substances, which possess the spontaneous by the long-range order .

In the ferrite ring the magnetic moments also are located in the determined order; however, this occurs not spontaneously, as it takes place in the magnetic bubbles. The magnetization of ferrite ring bears the goal-directed forced nature, and this process can be named the forced macroscopic crystallization of magnetic moments.

VI. CONCLUSION

Ferrite is soft-iron material and therefore it cannot be magnetized. However, the rings, made from ferrite, can be magnetized in the assigned direction. This special feature of the magnetization of such rings did not have, until now, of physical substantiation. In the article are examined the processes of the magnetization of the models of different configuration, including annular. It is shown that the magnetization of ferrite rings can be considered as the forced crystallization of magnetic moments.

REFERENCES RÉFÉRENCES REFERENCIAS

1. An Wang. U.S. Patent 2 708 722: Pulse transfer controlling devices.
2. Jay Forrester. U.S. Patent 2 736 880: Multicoordinate digital information storage device.
3. Китайгородский А. И. Физика для всех: Электронны. 2-е изд., перераб. - М.: Наука. Главная редакция физ.-мат. литературы, 1982. с. 122-124. - 208 с.



This page is intentionally left blank